





Product:
ESE 110 TP



-  Liquid cooling
-  50 Hz
-  Three-phase
-  Diesel



DIESEL GENERATOR ESE 110 TP	STANDBY POWER (ESP)	PRIME POWER (PRP)
Power (kVA)	110	100
Power (kW)	88	80
Speed (rpm)	1500	
Voltage (V)	400/ 230	
Power factor (cos phi)	0,8	
Amperage (Amp)	145	

Endress Group Romania S.R.L. certifications:
ISO 9001: 2008, ISO 14001: 2005, ISO 18001 : 2008.

ZENESSIS generators are CE compliant, and are tested according to the EU legislation on noise levels 2000/14 / EC.

Reference ambient conditions: 1000 mbar; 25° C; 30% relative humidity; power according to ISO 3046 / ISO 8528 standards.

Prime power (PRP) – ISO 8528

Prime power (PRP) – represents the continuous power a generator is able to provide continuously while supplying a variable electrical load when operating for an unlimited number of hours per year, under the agreed operating conditions, maintenance intervals and procedures being performed as prescribed by the manufacturer.

Standby Power (ESP) – ISO 8528

Standby Power (ESP) is the maximum power available at a variable load, under the operating conditions provided, that a generator is able to provide in case of power failure or under test conditions, maintenance intervals and procedures being performed as prescribed by the manufacturer.

Endress Group Romania S.R.L.

Offices:

Bucharest: km 16 A1 – Ciorogarla, Sos. Bucuresti, Nr. 108

Production:

Germany, Grafenberg, Werner von Siemens Str. 3

Romania, Bocsa, Str. Medresului, Nr. 17, Caras-Severin County..

1. DIESEL ENGINE

ENGINE SPECIFICATIONS	
Type	PERKINS
Model	1104C-44TAG2
No. of cylinders & arrangement	4 in line
Induction system	Turbocharged
Cooling system	Liquid cooling
Standby power (kWm)	103
Speed (rpm)	1500
Displacement (l)	4,41
Bore & Stroke (mm)	105 x 127
Compression factor	18,2:1
Regulator	Electronic
Total oil capacity (l)	8
Coolant capacity of engine (l)	12,6
Fuel consumption at 100% load in prime mode (l / h)	17,1

2. ALTERNATOR

ALTERNATOR SPECIFICATIONS		Leroy Somer or Strathon
Model	TAL044D or ECO 110 KW	
Frequency (Hz)	50	
Concept	Brushless, 4 poles	
Phases	3 + n	
Voltage(V)	400 / 230	
Protection class	H	
Excitation system	Electronic	
Performance	93%	
Protection	IP23	
Certification test	EN 10204 : 2001	

3. PANOUL COMANDA

Made in metal box, IP54 degree, with lock. The control panel is equipped with the ComAp AMF25 control module, with the possibility of starting and stopping the generator, both in automatic and in electric mode. The control panel monitors the power grid and can command and control the ATS panel (automatic transfer switch).

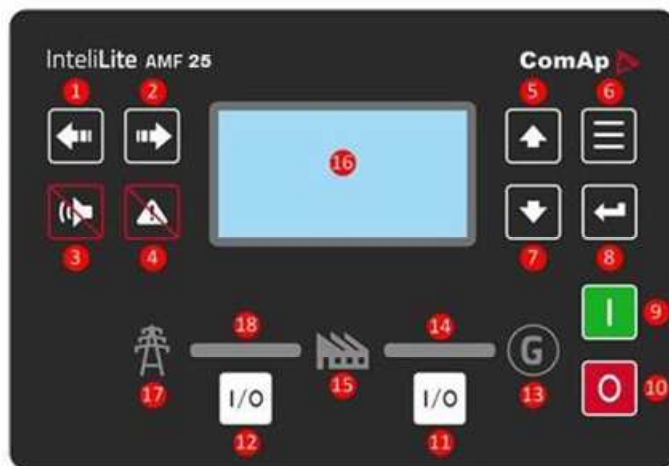

1. **Left** button
2. **Right** button
3. **HORN RESET** button
4. **FAULT RESET** button
5. **UP** button
6. **PAGE** button
7. **DOWN** button
8. **ENTER** button
9. **START** button
10. **STOP** button
11. **GCB** button. Works in MAN and TEST modes only
12. **MCB** button. Works in MAN and TEST modes only
13. **GENERATOR** status indicator
14. **GCB ON**. Green LEDs are on if GCB is closed and Gen-set is healthy.
15. **LOAD**
16. **Graphic B/W display**, 132x64 pixels
17. **MAINS** status indicator
18. **MCB ON**. Green LEDs are on if MCB is closed and Mains is healthy

◆ Control panel standard specifications:

The command and control panel is mounted inside the casing, in a metal box with IP 54, equipped with a viewing glass, equipped with:

- ComAp AMF 25 command module
- Static battery charger
- Emergency stop button & circuit breaker fuses
- Overcurrent differential protection
- Protection relays

Configuration:

1. ComAp AMF 25 command module
2. Circuit Breaker protection
3. Locks
4. Alarm
5. START button ON/OFF
6. Hinges
7. Maintenance schedule
8. Metal box

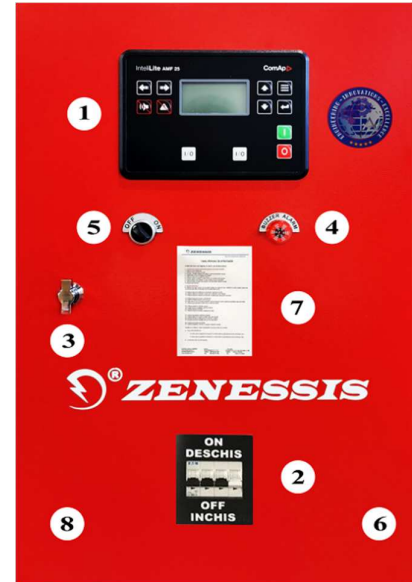

◆ Command module standard specifications:

- Microprocessor control
- 132 x 64 pixel LCD display
- Programming on front panel as well as through PC software
- Control buttons and soft touch navigation
- Remote communication via USB or with optional modules via RS232, RS485, Ethernet or SMS
- Store 350 events with date and time
- Maintenance programming 3 levels
- Engine heater control – Optional

• Displays:

Engine: engine speed; oil pressure; coolant temperature; running time; battery voltage; maintenance data.

Alternator: voltage (L – L, L – N); current (L1 – L2 – L3); frequency; kW; Pf; kVAr; kWh, kVAh, kVarh; phase sequence.

Main network: voltage (L – L, L – N); frequency, mains ready; mains off; generator set ready, generator set disconnected, active power kW, apparent power kVA, reactive power kVA r, power factor, phase sequence.

- **Warning:** battery faulty charging, low battery voltage, fail to stop, low fuel level, overload, phase reversing, speed sensor failure.
- **Alarms:** low oil pressure, high engine temperature, under / over voltage, under / overfrequency, under / overvoltage, ECU fault -optional.
- **Status displays:** missed start, emergency stop, low oil pressure, high engine temperature, under / overspeed, under / overfrequency, under / overvoltage, oil sensor, phase rotation, overload, overcurrent group, phase reversal.

◆ **Static battery charger:** Made with TSD technology, with high efficiency. Protected for short-circuit currents, it can be used as a current source, input voltage 196-264 V, output voltage 27.6 V / 5A or 13.8 V / 5A.

◆ Standards:

Electrical safety / EMC, BS EN 60950; BS EN 60950 – 6 – 2 EMC; BS EN 61000 – 6 – 4 EMC.

4. HOUSING

Made of galvanized steel, painted in electrostatic field, soundproofed. It is modularly designed with in-door access doors on all sides of the generator. The exhaust pan is residential type, mounted inside the casing. The carcasses are designed to optimize the cooling of the engine and alternator assembly, and can be mounted outdoors, providing protection against weathering and low noise levels.

1. Command module
2. View window
3. Access door for control module
4. Points for crane lifting (optional)
5. Spaces for handling with the forklift
6. Engine and alternator access door
7. Hot air outlet grills
8. Handles provided with locks
9. Fuel supply bus (optional)
10. „Sleigh chassis” fitted with lifting/pulling holes
11. Emergency button
12. Exhaust Gas Valve
13. Cable access space
14. Air intake grills
15. Protective pads

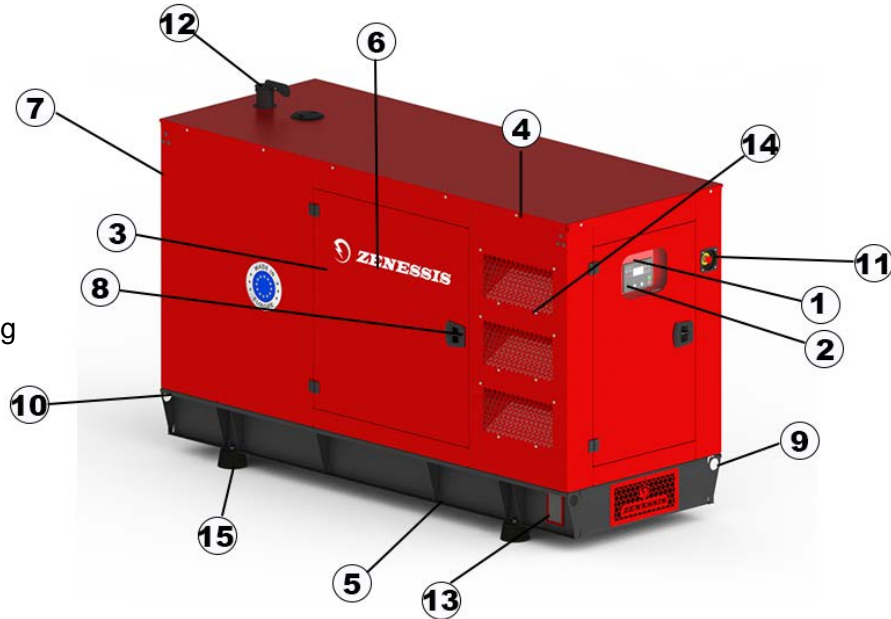

5. DIMENSIONS & WEIGHT

Opened generator sizes & weight	
Sizes (length x width x height) (mm)	2690 x 1010 x 2050
Weight (kg)	1120
Fuel tank capacity (liters)	200
Noise level (from distance of 7m)	82 db
Closed generator sizes & weight	
Sizes (length x width x height) (mm)	2890 x 1110 x 1750
Weight (kg)	1550
Fuel tank capacity (liters)	200
Noise level (from distance of 7m)	70 db

6. STANDARD FEATURES

Control & comand panel with indicators and measuring devices, IP 54 protection



Thermostatic heater for cooling liquid



Stating charger for charger



Oversized starting battery



Dinamic alternator for battery charging



Emergency stop button



Chassis with fuel tank dimensioned for an 8 hour autonomy



Protective pads



Vibration dampers



Metal hinges



Device for measuring fuel level



Access doors provided with locks



Electric lines protected by tubing and seal



System for manipulation with crane or forklift



Residential exhaust pipe



Fireproof antiphonic pillow



7. OPTIONAL FEATURES

Anti-condensation embedding system for electric panels



Liquid retention tray



Heating system for fuel/ oil



Liquid leak detection sensor



Circulation pump for heating cooling liquid



Remote monitoring & control system



Oil evacuation pump



Exterior fuel filler cap with lock



Motorized AAR, patented invention ENDRESS-Patent OSIM 00048/2015



Pocket system integrated in the chassis for lifting with forklift



AAR Transfer panel for 3/4 poles



Fire extinguisher with internal housing support



3/4 poles differential protection



Super soundproof housing



Sockets 400V/ 230V



Intake air heating spark plug



Fuel filter with water detection



Grounding electrodes



Bypass panel-patented invention ENDRESS-Patent OSIM 00010/ 2012



Fuel transfer automatic pump



Auto trailer



Mobile distribution panel with 4 sockets



Remote control start



Cable reel



Lack of grounding protection



Fire detector with automatic shutdown generator set



Interior lighting with switches operated at door opening



Fire extinguishing system with inert gas



Optional: RAR homologated auto trailer

Model: EGR 2000

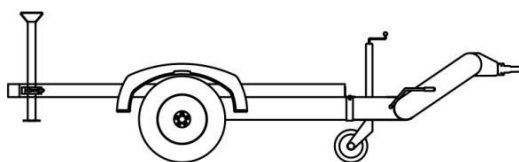
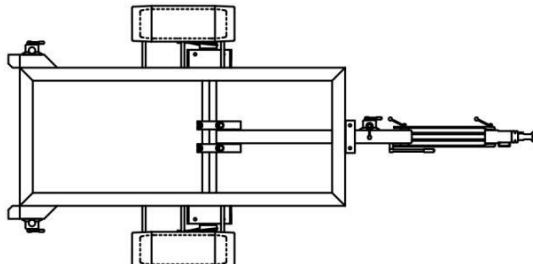

Created in Germany – Assembled in Romania
Warranty: 24 months or 3000 operating hours

ENDRESS PRODUCTS ARE IN A CONTINUOUS DEVELOPMENT AND IMPROVEMENT PROCESS. FOR THIS REASON, ENDRESS GROUP ROMANIA RESERVES THE RIGHT TO MODIFY THE INFORMATION FOUND IN THESE LEAFLETS WITHOUT PRIOR NOTIFICATION